

RM06090NOCXH1

Part number	RM06090NOCXH1
Number of resistor elements	NO/Single-unit
Lever direction	Vertical
Travel	60mm
Type	Motor N fader
Lever type	Optional

Lever length	Optional
Total resistance	500 Ω -1.000k Ω
Resistance taper	Optional
Terminal type	For PC board
Touch sense track	Yes
Operating temperature range	-10°C--+70°C

Electrical characteristics

Total resistance tolerance	$\pm 20\%$ Other
Rated power	0.05W
Max. operating voltage	500V AC, 10V DC
Rated voltage of motor	10V DC
Max. current of motor	800mA or less (at 10V DC)
Sliding noise	less than 100mV
Insulation resistance	100M Ω min., 250V DC
Voltage proof	250V AC for 1 min.

Mechanical characteristics

Operating force	0.8 ± 0.5 N
Stopper strength	100N.m
Lever push-pull strength	50N
Lever wobble (2 sides)	1.3mm
Lever deviation (1 side)	0.5mm max.

Durability	Operating life	100.000 ± 2.000 cycles
		Other _____ ± 2.000 cycles

MOQ	80pcs
-----	-------

Photo

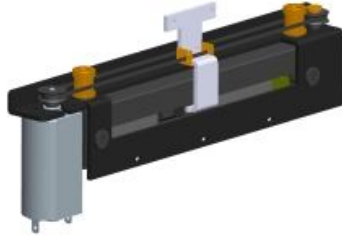

Dimensions

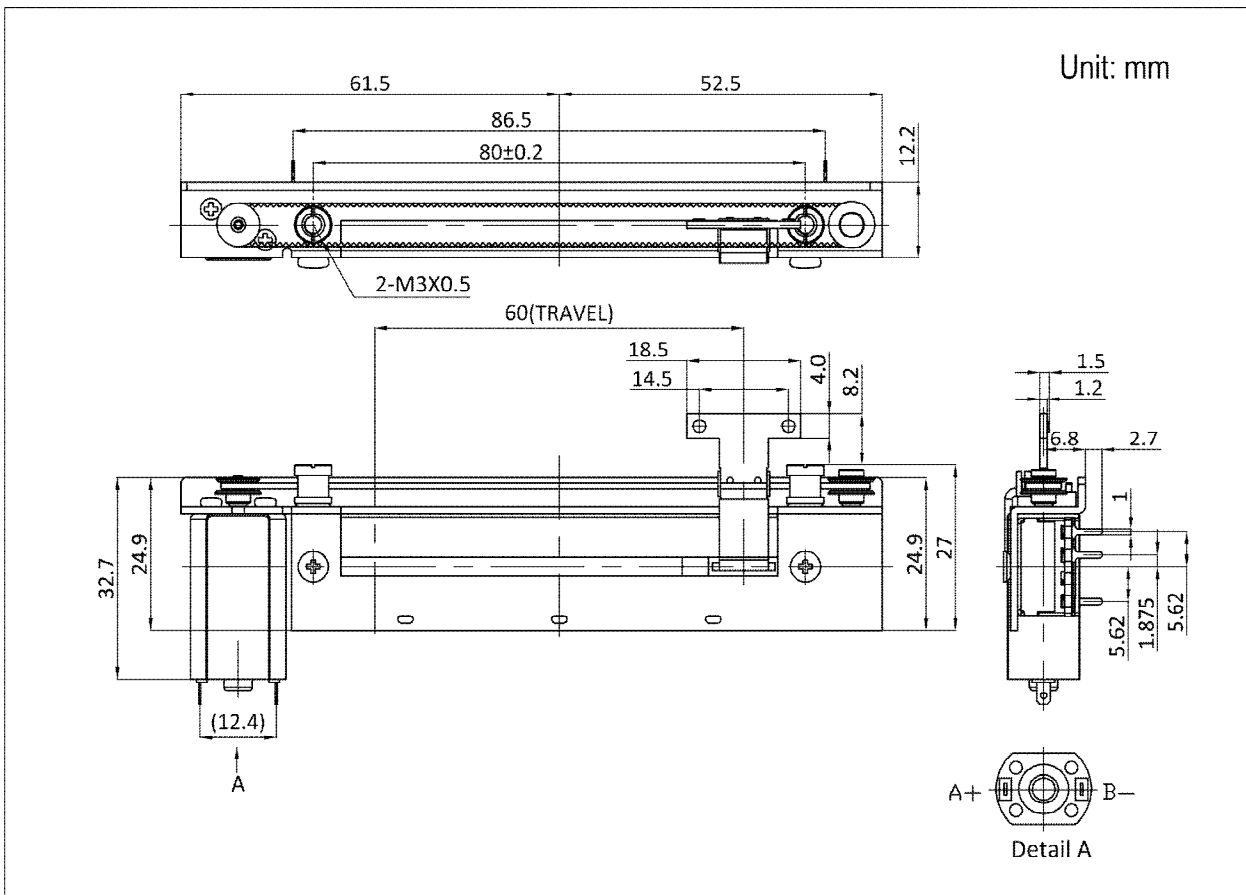

Mounting Hole Details

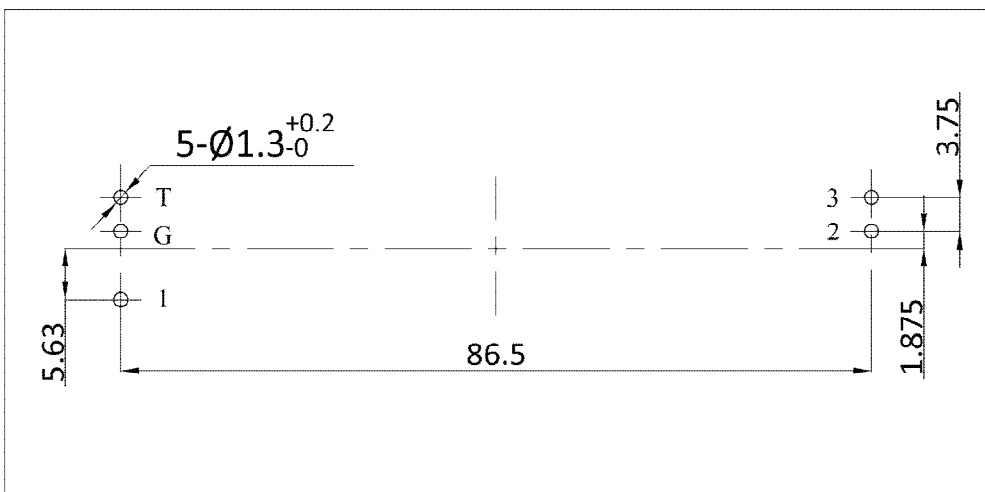

Motor

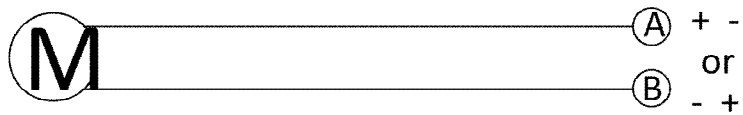

moving direction of lever and contacts

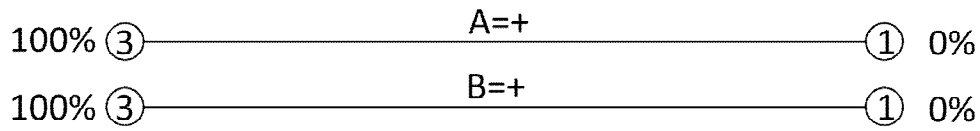

Servo track

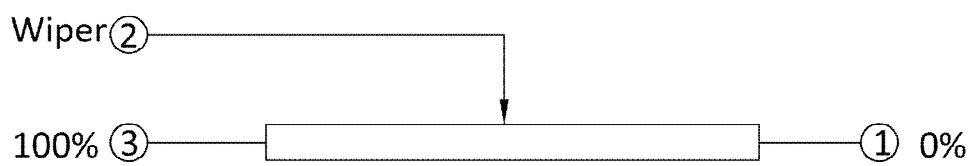

Touch sense track

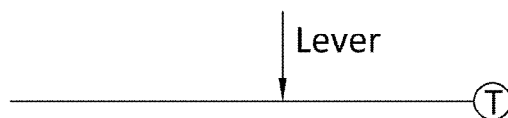

Resistance Taper Options

A Taper	B Taper	C Taper	MN
05 A	1 B	05 C	M
10 A	2 B	10 C	N
15 A	3 B	15 C	
20 A	4 B	20 C	
25 A		25 C	
30 A		30 C	

Packing specifications

Quantity per carton	160pcs with travel of 60mm
Packing method	Blister box
Carton dimension	350X275X250mm

Soldering conditions

Wave soldering

Soldering surface temperature	100°C max.
Heating time	2 min. max.
Soldering temperature	260°C \pm 5°C max.
Soldering time	5 \pm 1s
No. of solders	1 time max.

Hand soldering

Tip temperature	350°C max.
Soldering time	3s max.
No. of solders	1 time
